

Dichtungsprofile für alle Stahlzargen, Standardprogramm >>









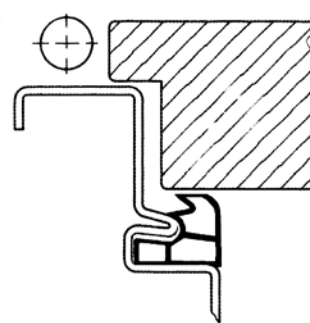
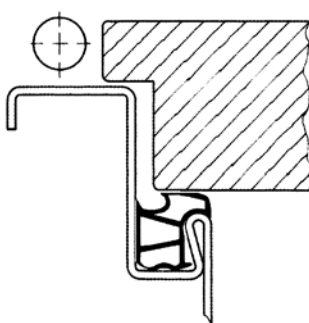
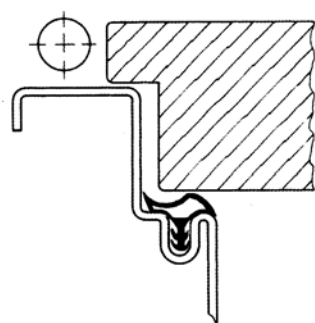





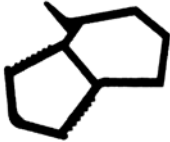





M E D I N A G E N

MEDinagen – Ihr zuverlässiger Partner für
Dichtungsprofile und Formteile für alle Einsatzgebiete
in allen gängigen Werkstoffen

Stahlzargendichtungen, Standardprogramm >>



| | | | | |
|---|---|---|---|---|
|  |  |  |  |  |
| K 2029 | K 2081 | K 2086 | K 2089 | K 2090 |
|  |  |  |  |  |
| K 2098 | K 2110 | K 2111 | K 2122 | K 2124 |
|  |  |  |  |  |
| K 2129 | K 2135 | K 2150 | K 2155 | K 2157 |
|  |  |  |  |  |
| K 2160 | K 2161 | K 2162 | K 2164 | K 2165 |



M E D I N A G E N

MEDInagen Gesellschaft mbH.





















GUMMI- UND KUNSTSTOFF- ERZEUGNISSE

www.medinagen.com · info@medinagen.com

Osterstraße 81 · 20259 Hamburg

Telefon +49 (0) 40 / 5 70 89 11 · Telefax +49 (0) 40 / 5 70 89 03

Stahlzargendichtungen, Standardprogramm, Fortsetzung

| | | | | |
|---|---|---|---|---|
|  K 2168 |  K 2169 |  K 2171 |  K 2172 |  K 2173 |
|  K 2174 |  K 2175 |  K 2177 |  K 2179 |  K 2180 |
|  K 2189 |  K 2190 |  K 2250 |  K 2256 |  K 2277 |
|  K 2278 |  K 2286 |  K 2295 |  K 2312 |  K 2378 |

Diese Übersicht zeigt nur einen kleinen Ausschnitt aus unserem Lieferprogramm. Weitere Dichtungsprofile stehen Ihnen für Ihre Anwendung zur Verfügung. Gern erwarten wir Ihre Anfrage.



M E D I N A G E N

MEDInagen Gesellschaft mbH.

GUMMI- UND KUNSTSTOFF- ERZEUGNISSE

www.medinagen.com · info@medinagen.com

Osterstraße 81 · 20259 Hamburg

Telefon +49 (0) 40 / 5 70 89 11 · Telefax +49 (0) 40 / 5 70 89 03

Was Sie hier nicht gefunden haben,
finden wir für Sie –
bitte sprechen Sie uns an.

MEDInagen – Ihr zuverlässiger Partner
für Dichtungsprofile und Formteile für alle
Einsatzgebiete in allen Werkstoffen



M E D I N A G E N

MEDInagen Gesellschaft mbH.

GUMMI- UND KUNSTSTOFF- ERZEUGNISSE

www.medinagen.com · info@medinagen.com

Osterstraße 81 · 20259 Hamburg

Telefon +49 (0) 40 / 5 70 89 11 · Telefax +49 (0) 40 / 5 70 89 03